

# JB SANITARY

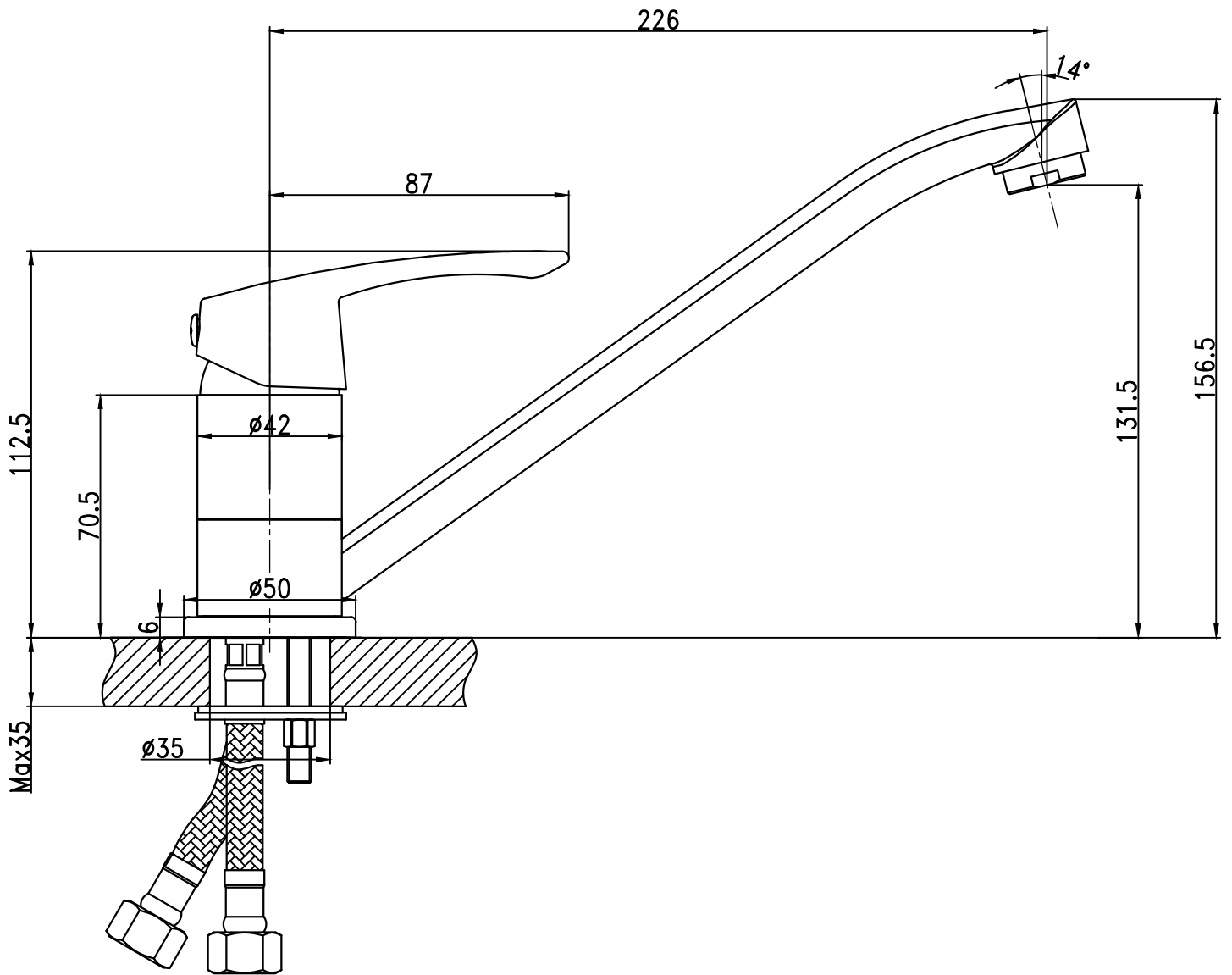

**L10 21 00**